

Parallon

MEETING, CAFÉ AND OCCASIONAL DISC-BASE TABLE ASSEMBLY INSTRUCTIONS

Everything to the table.

When you want cohesion in spaces large, small, shared or separate, there's Parallon. It's a single collection with a singular look, offering an array of choices for a variety of environments—and all the features to fit.

Ensure design is never a distraction in the places where everyone needs to focus. Our Parallon line of cafe and occasional tables provides a unified and streamlined look from room to room.

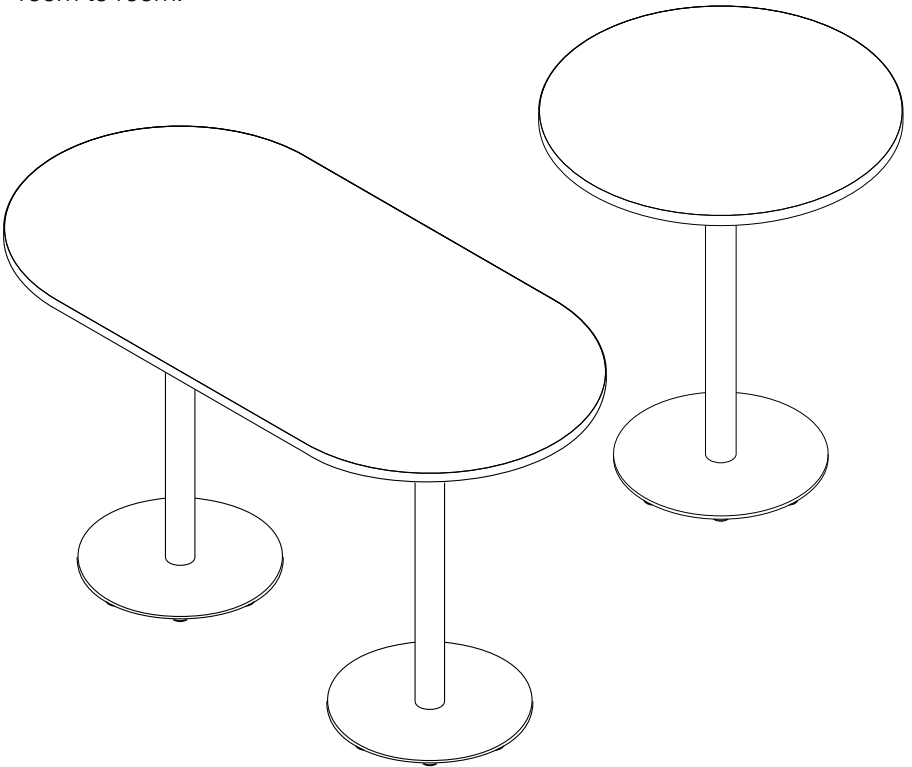

Read the entire instruction manual before you start installation and assembly. If you have any questions regarding any of the instructions or warnings, please contact your local distributor for assistance.

To report any issues with this product, contact our customer experience team at: (888) 274-8664 or sitonit@exemplis.com.



CAUTION

Failure to follow instructions could result in product failure or potential injury.

Do not apply sudden weight to table.

Do not exceed 200 lb static load weight capacity.

Recommended Tools

- Cordless Drill/Driver
- #3 Phillips Bit
- $\frac{5}{32}$ " Hex Bit
- $\frac{1}{2}$ " Hex Socket, $\frac{1}{4}$ " Drive
- Hex Shank to $\frac{1}{4}$ " Square Drive Adapter

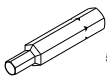

$\frac{5}{32}$ " Hex Bit

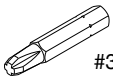

#3 Phillips Bit

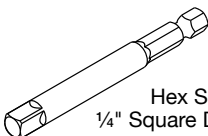

Hex Shank to
 $\frac{1}{4}$ " Square Drive Adapter

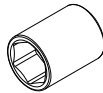

$\frac{1}{2}$ " Hex Socket,
 $\frac{1}{4}$ " Drive

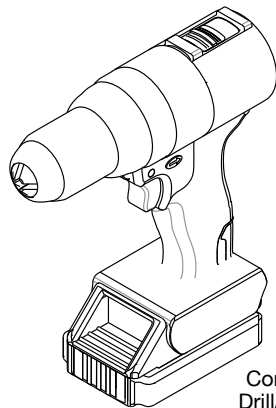

Cordless
Drill/Driver

Parts *(Double all component parts for racetrack and rectangular tabletops.)*

- Tabletop (1, round, square, racetrack or rectangular)
- Top Plate (1)
- Column (1)
- Disc Base (1)
- **Pack A:**
 - #12 × 1" Screw (8)
- **Pack B:**
 - 5/16" × 1 1/2" Bolt (2)
- **Pack C:**
 - 1/4" × 1" Screw (4)

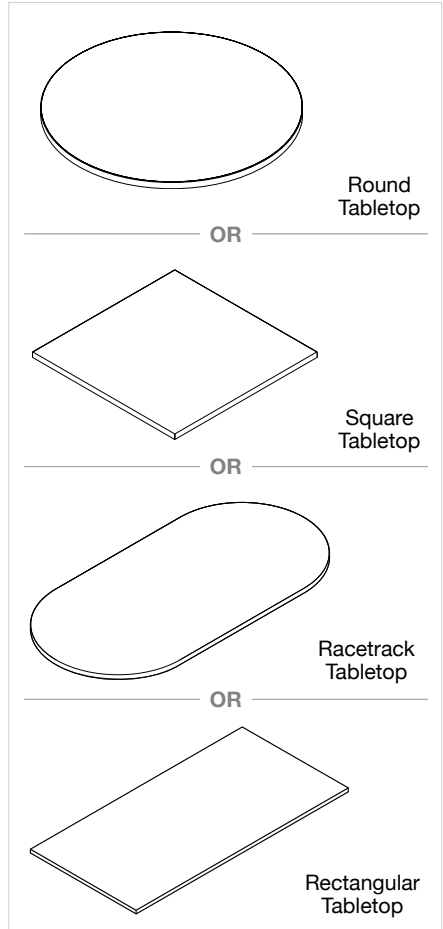
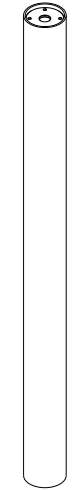
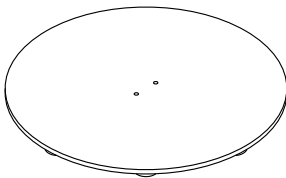
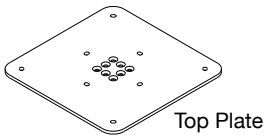

PACK A

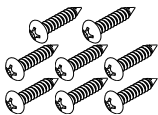

#12 × 1" Screws

PACK B

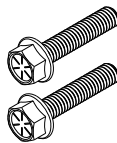

5/16" × 1 1/2" Bolt

PACK C



1/4" × 1" Screw

Step 1: Attach the top plate to the column.

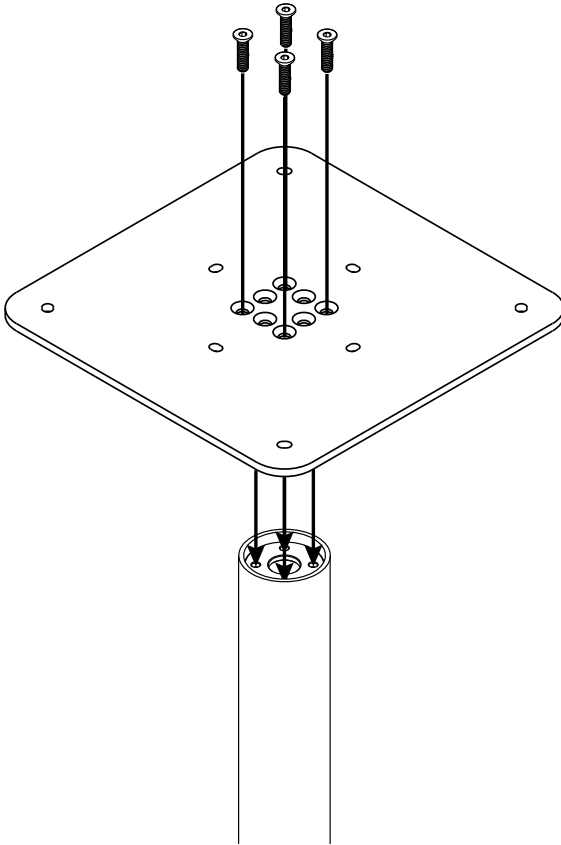

1:1 HARDWARE

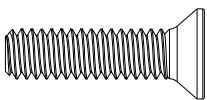

1/4" x 1" Screw (Pack C)

TOOLS

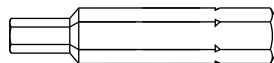

5/32 Hex Drill Bit

Step 2: Attach the column assembly to the tabletop.

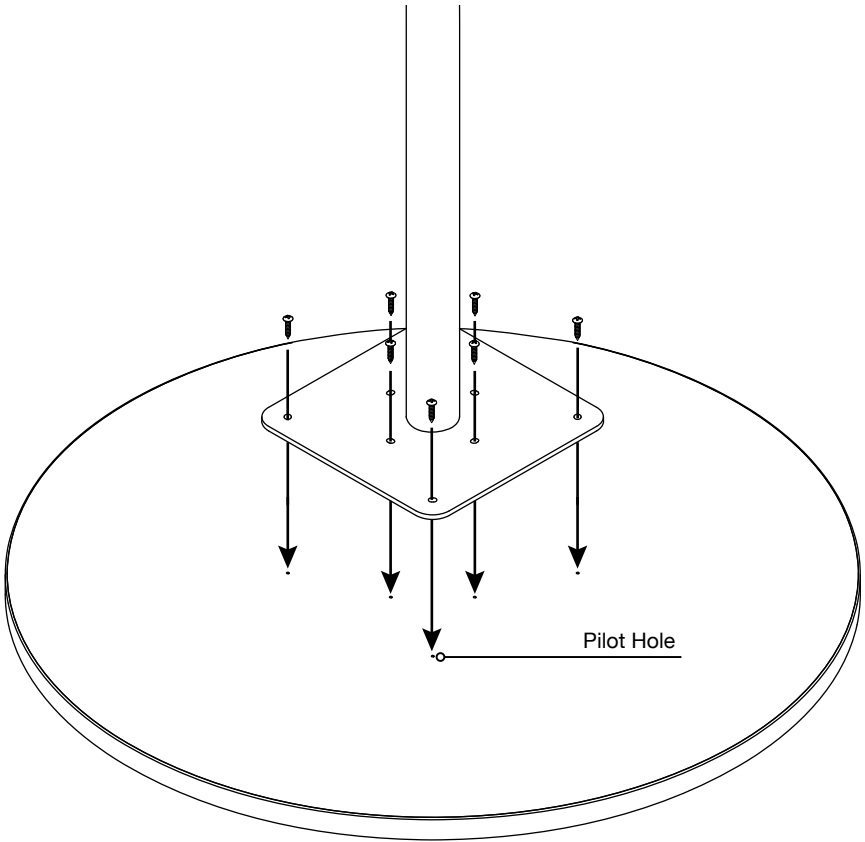

1:1 HARDWARE

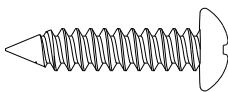

#12 x 1" Screw (Pack A)

TOOLS

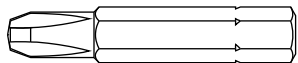

#3 Phillips Bit

Step 3: Attach the disc base to the column.

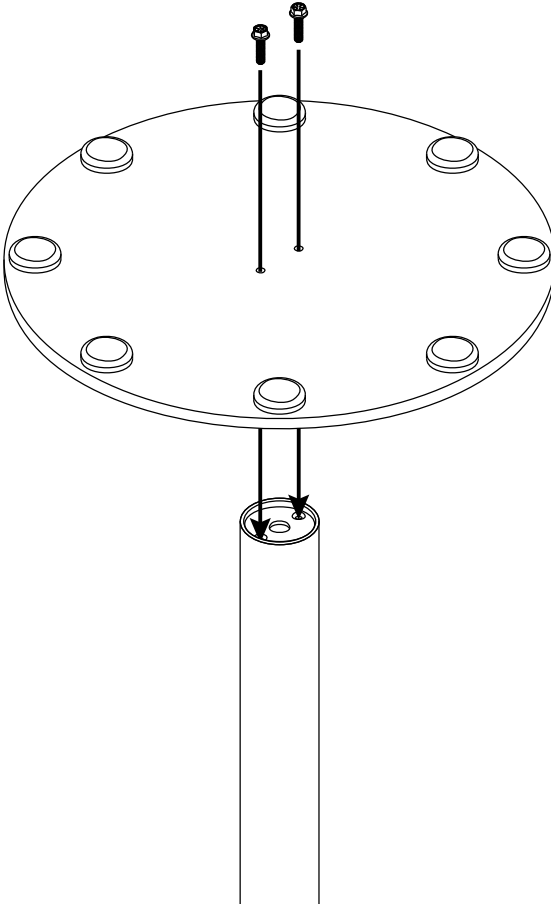

1:1 HARDWARE

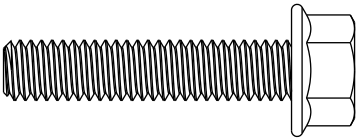

5/16 x 1 1/2" Bolt (Pack B)

TOOLS



1/2" Hex Socket, 1/4" Drive



Hex Shank to Square Drive Adapter

Step 4: Turn the table upright with the help of another person.

Note: Use packaging to prevent damage to the disc base when turning the table upright.

